

# PREXISO

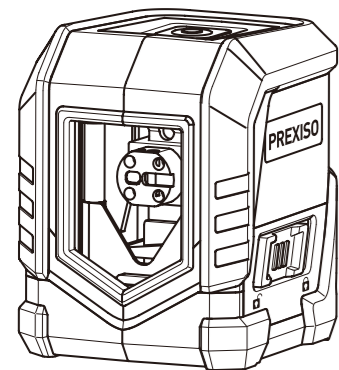

## 65FT/20M GREEN-BEAM SELF-LEVELING CROSS LINE LASER



### IMPORTANT SAFETY INSTRUCTIONS

Working safely with the measuring tool is possible only when the operating and safety information are read completely and instructions contained herein are strictly followed. Never make warning labels on the measuring tool unrecognizable. **SAVE THESE INSTRUCTIONS.**

Caution – The use of operating or adjusting equipment or the application or processing methods other than those mentioned herein, can lead to hazardous radiation exposure.



Laser radiation-Do not stare into beam.  
Class II Laser product. Complies with 21 CFR 1040.10 and 1040.11 except for conformance with IEC 60825-1 Ed. 3, endorsed in Laser Notice No. 50, dated May 8, 2019.



### WARNING

**LASER RADIATION.** Do not stare into beam. Class II laser product. Turn the laser beam on only when using this tool.

- Do not remove or deface any product labels.
- Avoid direct eye exposure. The laser beam can cause persons being blinded.
- Do not operate the tool around children or allow children to operate the tool.
- Do not place the tool in a position that may cause anyone to stare at the laser beam, whether intentionally or unintentionally.
- Do not use on reflecting surfaces such as sheet steel, glass or polished metal etc. that have shiny, reflective surfaces. The shiny surface could reflect the beam back at the operator.
- Always turn the laser tool off when not in use. Leaving the tool on increases the risk of someone inadvertently staring into the laser beam
- Do not attempt to modify the performance of this laser device in any way. This may result in a dangerous exposure to laser radiation.
- Do not attempt to repair or disassemble the laser-measuring tool. If unqualified persons attempt to repair this product, serious injury may occur. Any repair required on this laser product should be performed only by qualified service personnel.
- Use of other accessories that have been designed for use with other laser tools could result in serious injury.

- Do not operate the tool outdoors.
- Do not place or store tool under extreme temperature conditions.
- Do not operate the tool in explosive environments, such as in the presence of flammable liquids, gases or dusts. Sparks can be created in the tool which may ignite the dust or fumes.
- Keep the tool away from cardiac pacemakers. The magnet inside the tool generates a field that can impair the function of cardiac pacemakers.
- Keep the tool away from magnetic data medium and magnetically-sensitive equipment. The effect of the magnetic can lead to irreversible data loss.
- Measurement may not be accurate if used beyond the rated range of the device.
- The use of optical instruments with this product will increase eye hazard.
- Always make sure any bystanders nearby aware of the dangers of looking directly into the measuring tool.
- Do not use the laser viewing glasses as safety goggles, they do not protect eyes against laser radiation.
- Always remove the batteries when cleaning the laser light aperture to laser lens.

### TECHNICAL SPECIFICATIONS

COMPONENT	SPECIFICATIONS
Laser	$\lambda=510-530\text{nm}$ , Class 2 laser, maximum laser output<1mW
Operating range (typically)	65FT (20M)*
Accuracy (typically)	$\pm 5/16\text{IN}@30\text{FT}$ ( $\pm 8\text{mm}@10\text{m}$ )*
Self-leveling range	$\pm 4^\circ$
Estimated battery life	>5 hours (alkaline batteries)
Optimum operating temperature	32°F to 104°F (0°C to 40°C)
Storage temperature	14°F to 140°F (-10°C to 60°C)
Batteries	2 x 1.5V alkaline AA

\*Important: The accuracy is rated within distance of 10 meters. Under unfavorable conditions, such as in extreme interior illumination, transparent surfaces (eg. glass, water), porous surfaces (eg. insulation materials) or reflecting surfaces (eg. polished metal, glass) or very rough surfaces (eg. rough cast, natural stone), the tool's measuring range and accuracy will be reduced.

### DESCRIPTION

#### KNOW YOUR SELF-LEVELING CROSS LINE LASER

This self-leveling cross line laser is a highly versatile tool. It can be placed on the ground, mounted on a door frame or work bench etc. when use the appropriate accessories eg. mounting clamp(included), tripod(not included) etc. but not limited.  
• Self-leveling levels within +4 degrees to -4 degrees with an accuracy of  $\pm 5/16\text{IN}@30\text{FT}$  ( $\pm 8\text{mm}@10\text{m}$ ).  
• AA alkaline batteries

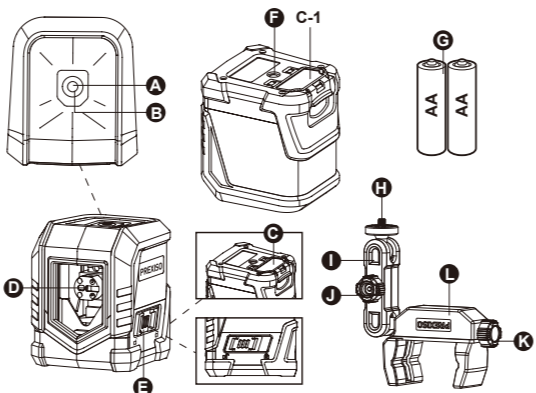

PARTS	DESCRIPTION
A	Ring-button
B	LED indicator (red: levelling off, green:levelling on)
C	Battery compartment
C-1	Battery compartment cover
D	Laser beam aperture
E	LOCK switch
F	1/4"-20 thread (underneath)
G	1.5V AA batteries
H	1/4"-20 screw
I	Rod
J	Knob 2
K	Knob 1
L	Handle

### UNPACKING

When unpacking the box, do not discard any packing materials until all of the contents are accounted for:  
• Self-Leveling Cross Line Laser Tool  
• Clamp  
• 2 x AA alkaline batteries  
• Instruction manual

Carefully lift the compact laser measuring tool out of the package and place it on a stable, flat surface.

### ASSEMBLY

#### INSERTING/REPLACING THE BATTERY

AA alkaline batteries are recommended for the measuring tool. To open the battery compartment lid, press the latch and open it. Insert the batteries provided. Pay attention to the correct polarity of the batteries according to the representation on the metal plate inside the lid.

Always replace all batteries at the same time. Only use batteries from one brand and with the identical capacity.

NOTE: Remove the batteries from the measuring tool when not using it for extended periods. When storing for extended periods, the batteries can corrode and discharge themselves.

### OPERATION

#### 1. Switching on / off

To switch the product on, push the LOCK switch E to the position while the product is on a flat and horizontal surface (< 4 °). Immediately after being switched on, the product projects two laser lines from the laser beam aperture D .

To switch the product off, push the LOCK switch E to the position . When switched off, the pendulum unit is locked.

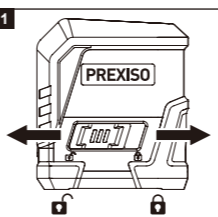

#### 2. Work with automatic leveling system or automatic self-leveling mode

To work with automatic leveling, place the product on a flat and firm surface, or fasten it with the 1/4"-20 thread F to the 1/4"-20 screw H of included clamp.

When it is switched on, the automatic leveling system automatically corrects irregularities of  $\pm 4^\circ$  within the self leveling area. The leveling is completed when the laser lines stop moving and the LED indicator B goes green.

If automatic leveling is not possible, e.g. because the base of the measuring tool deviates by more than  $4^\circ$  from the horizontal or because the product is being freely hand-held, the LED indicator B will go red and the horizontal and vertical laser lines will be gone. **Note 1:** The LED indicator B will always be indicated red on manual mode operation. **Note 2:** if the product is agitated or its position is changed during operation, the product will automatically re-level. After re-leveling, check the positions of the horizontal and vertical laser lines against reference points to avoid errors. **Note 3:** The top Ring-button A has no function at this mode.

#### 3. Work without the automatic leveling system or with manual mode

Put the LOCK switch E into the position

Push and hold the ring-button A on the top of the product until the product projects two laser lines from the laser beam aperture D that are not leveled. The LED indicator B will always be indicated red on manual mode operation.

Push and hold the ring-button A on top again until the product switch off two laser lines from the laser beam aperture D at this mode.

#### 4. Practical guidance

Always use only the middle of the laser line for markings. The width of the line depends on the distance.

#### 5. Work with the included clamp

The highly versatile clamp allows the compact self-leveling cross line laser to work in various applications, such as mounted on a pipe, work bench, door frame etc. which is not over 2 inch thick (the maximum opening of clamp is 2 inch big).

- Tighten knob 1 to securely mount the clamp to a pole, pipe or other suitable item.
- Loosen knob 2 and adjust the 1/4" -20 screw knob to the desired position. After adjustment, tighten knob 2.
- Mount the compact self-leveling cross line laser to the 1/4" -20 screw securely.
- Loosen the knob 1 and adjust the orientation of the rod so that the laser beam projects to your target.
- Tighten the knob 1 again to lock the Clamp-Tool Assembly to the position.

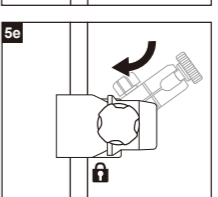
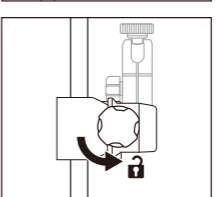
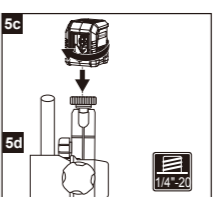
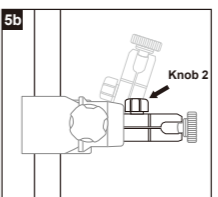
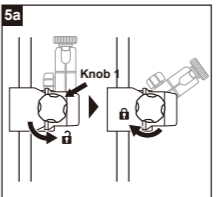

### APPLICATIONS

The compact self-leveling cross line laser can be placed on the ground, mounted on a work bench / door frame etc. for point marking and simple alignment by sight. It is ideal for the following applications:

- Hanging pictures, photos, or artwork on walls
- Wallpapering and stencil work
- Framing doors and windows
- Installing electrical wiring and pipes
- Mounting wall fixtures, electrical outlets, switches and lighting
- Installing a drop ceiling
- Painting
- Installing cabinets
- Laying tile and flooring

### MAINTENANCE

This compact laser measuring tool has been designed to be a low-maintenance tool. However, in order to maintain its performance, you must always follow these simple directions:

- Avoid exposing the tool to shock, continuous vibration or extreme hot or cold environment.
- Always store the tool indoors.
- Always keep the tool free of dust and liquids. Use only a clean soft cloth for cleaning. If necessary, slightly moisten the cloths with pure alcohol or a little water.
- Do not disassemble the compact laser measuringtool, this will expose the user to hazardous radiation exposure.
- Do not attempt to change any part of the laser lens.

### TROUBLE SHOOTING

PROBLEM	CAUSE	SOLUTION
The laser line projection is weak.	Batteries are weak.	Replace with new batteries.
The laser line is hard to see.	The tool is out of the rated operating range	Move the tool closer to be within the rated operating range.
Laser line is not projected.	No batteries installed or batteries are depleted.	Install new batteries.
The lasers gone and LED light on the top goes red on automatic leveling mode	The surface where the tool has been placed is uneven or the tool is out of its automatic self-leveling range.	Place the tool on flat surface levels within $\pm 4$ degrees.

### WARRANTY

Two-Year Limited Warranty. This product is warranted to the original purchaser from the original purchase date for two years subject to the warranty coverage described herein. Please retain your receipt. This product is warranted to the original user to be free from defects in material and workmanship. If you believe that the product is defective at any time during the specified warranty period, please contact Prexiso customer service agent by sending email to info@prexiso-eu.com. This warranty does not cover: (1) Part failure due to normal wear or product abuse; (2) Any parts have been altered or modified by anyone other than an authorized Prexiso personnel or failure to install and operate equipment according to the guidelines put forth in the instruction manual. (3)Any products or parts used for rental purposes, damage resulting from shipping (claims must be filed with freighter), accident, abuse, act of God, misuse, or neglect. Prexiso will replace or repair the defective unit, at its option, subject to verification of the defect. Any implied warranties arising from the sale of a Prexiso product, including but not limited to implied warranties of merchantability and fitness for a particular purpose, are limited to the above. Prexiso shall not be liable for loss of use of the product or other incidental or consequential damages, expenses, or economic loss, or for any claim of such damage, expenses, or economic loss. This warranty excludes any accessories. This warranty gives you specific legal rights, and you may also have other rights that vary from state.